

# 16'x56' 8-Bay Lean-to

16'x56' Bay 1

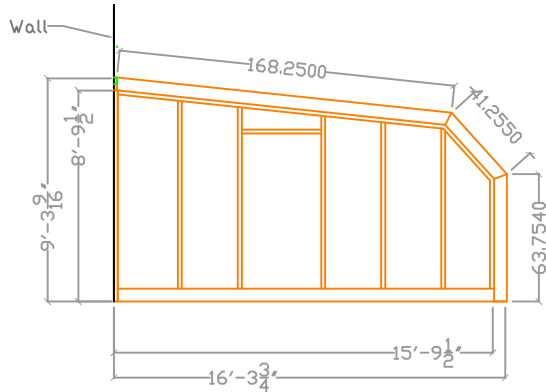

16'x56' Bay 2

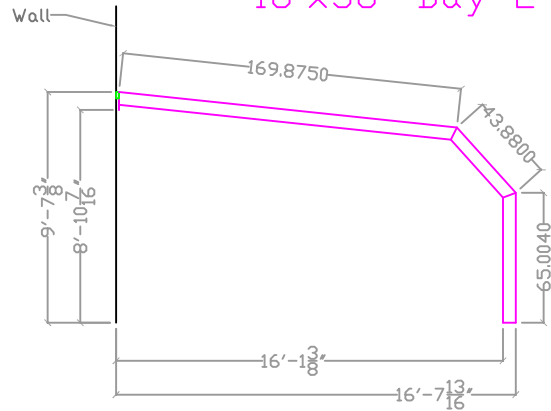

16'x56' Bay 3

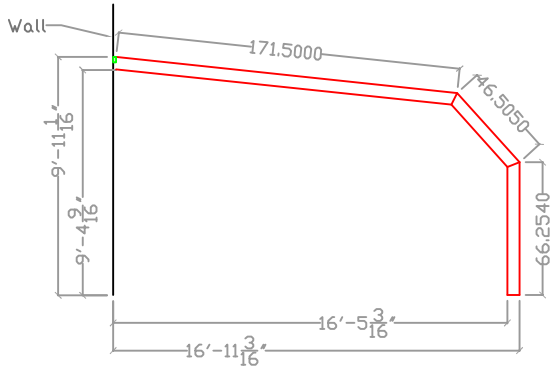

16'x56' Bay 4

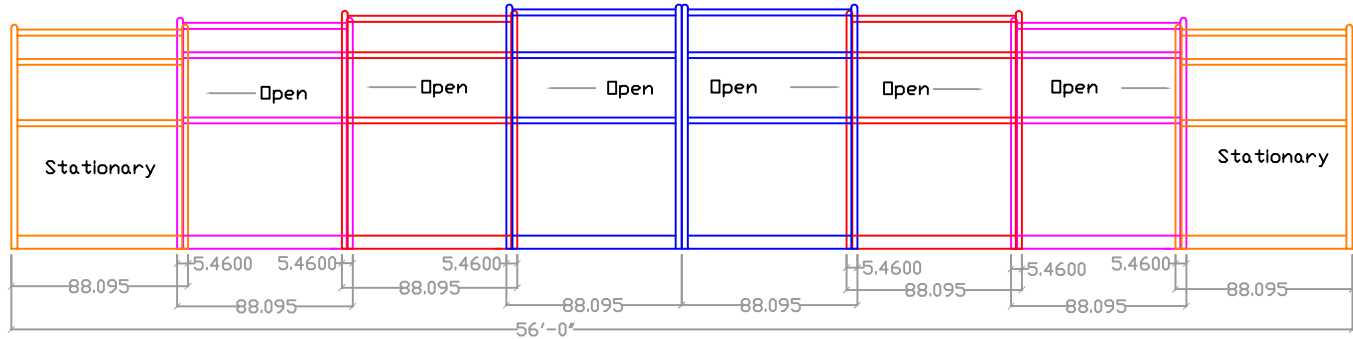
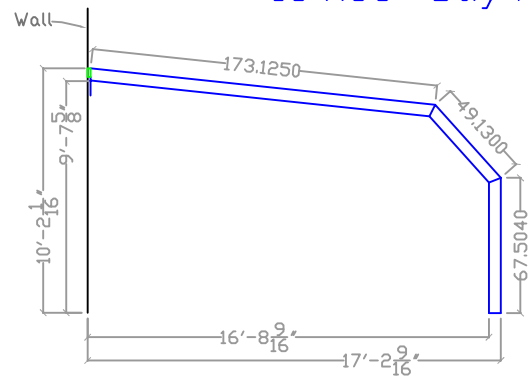

**Roll-A-Cover**  
 36 Sargent Drive  
 Bethany, CT 06524

Tel: 203-393-7292  
 Fax: 203-393-7298

Job Title: Lean-to Specifications

Date:

Drawing Name: 8LT44-168

Scale: 1/8" = 1'